



LED WARNING SIGN WITH HORN TYPE EK32

FEATURES

- Bright LEDs
- Flashing or continuous light
- Independent programming of LEDs and sounder in different alarm modes
- Double-sided signs
- Simple installation





Specifications

Supply voltage	24 VDC
Power consumption	Max 2 W
Protection class	IP52
LED lifetime	50 000 h
Volume	Ca 92 dB
Weight	400 g
Width	30 cm
Height	12 cm
Certifications	CE
Cabling	2 x 0,75 mm ² , shielded 2 x 2 x 0,75 mm ² , shielded

Wall-mount

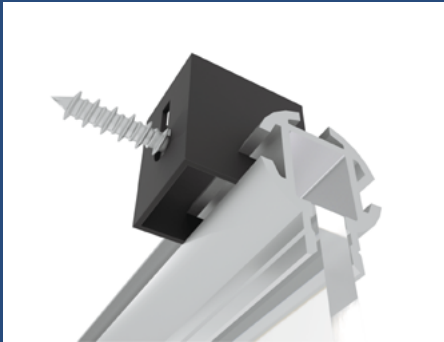

Ceiling-mount

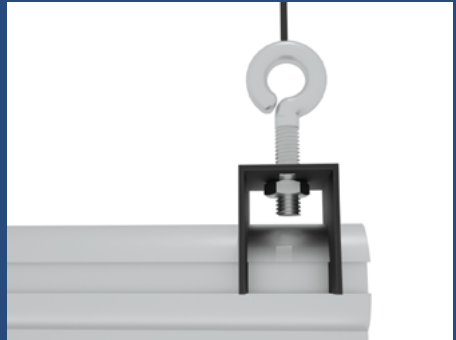
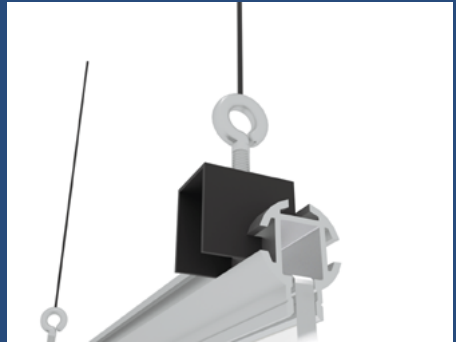

Cable connection scheme

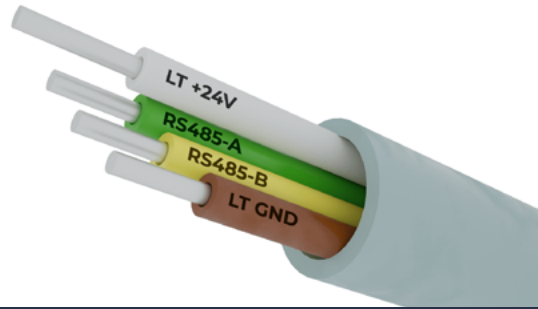

Wire color	Connection
White	LT +24V
Green	RS485-A
Yellow	RS485-B
Brown	LT GND